

Vario-X

Connected Future

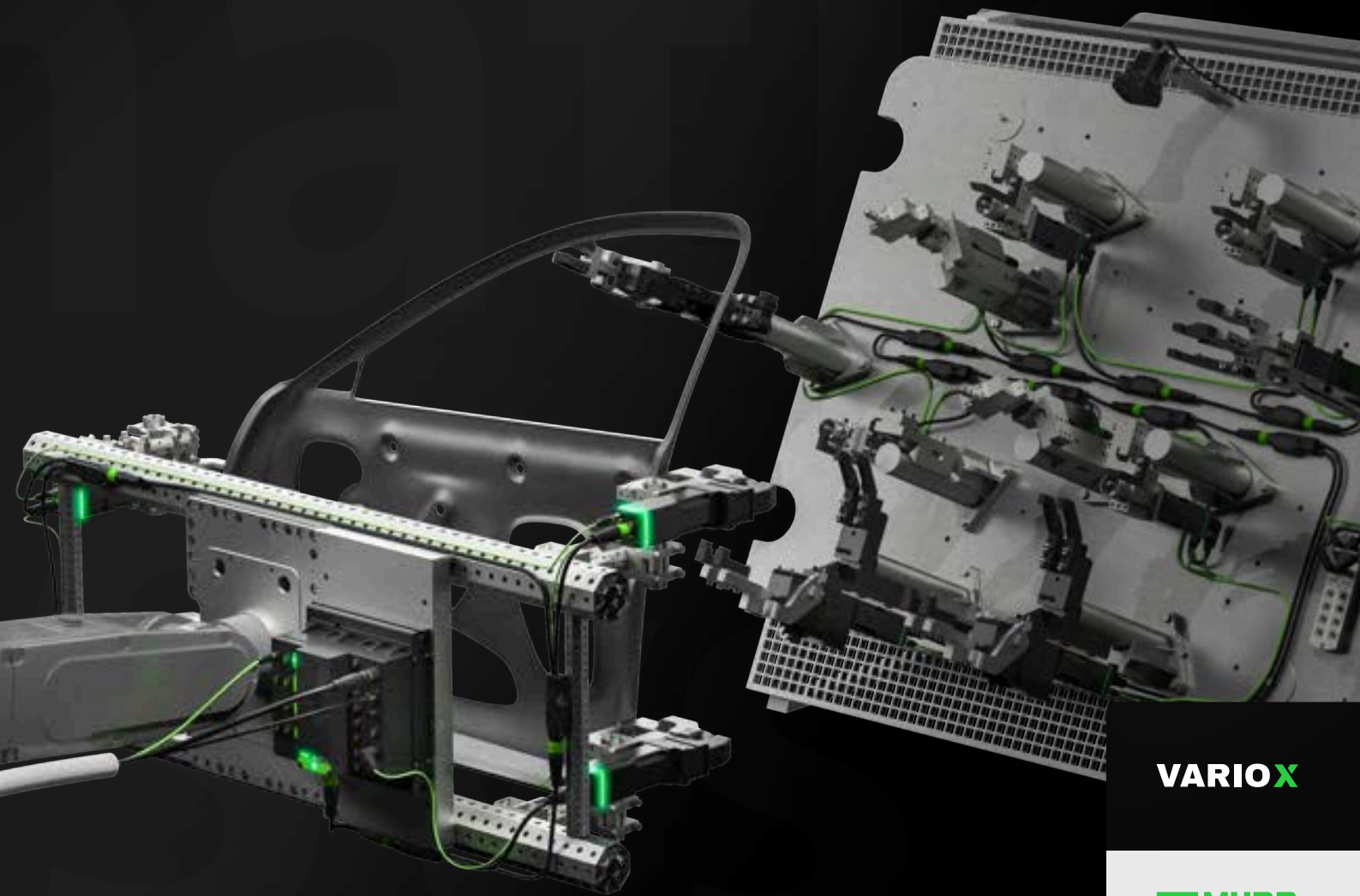

VARIO X

MURR
ELEKTRONIK
stay connected



Get the details

Learn how Vario-X can revolutionize your production.

Electric instead of pneumatic

Using electricity instead of pneumatics brings radical improvements. With Vario-X, the change is simple and sustainable: increased energy efficiency, reduced CO2 emissions and increased productivity are not just empty phrases.



Easy system design

Systems can be made more compact, freeing up space for production machines or additional workstations. Vario-X also reduces the need for sensors and cables, simplifies integration, and enables fast plug-and-play commissioning.



Less energy consumption

On average, a pneumatic clamping cycle uses seven times more energy than an electric one. In addition, compressed air is often lost due to leaks that are difficult to detect. Vario-X eliminates these losses and saves up to 95% energy.



Increased productivity

The Vario-X teach-in process and quick setup at the touch of a button significantly reduce changeover times. Lower failure rates and the option of predictive maintenance also reduce downtime and increase system availability.



Healthy working environment

Combining the Vario-X system with electric clamps significantly lowers noise levels and reduces disturbing noises. At the same time, the system improves air quality by reducing the emission of harmful oil particles.

95%

Less energy consumption

75%

Less components

53%

Increased productivity

Easy system design

Vario-X reduces the need for sensors and cables, simplifies integration through standardization, and enables rapid commissioning through plug-and-play installation.

Up to 75% fewer cables and sensors

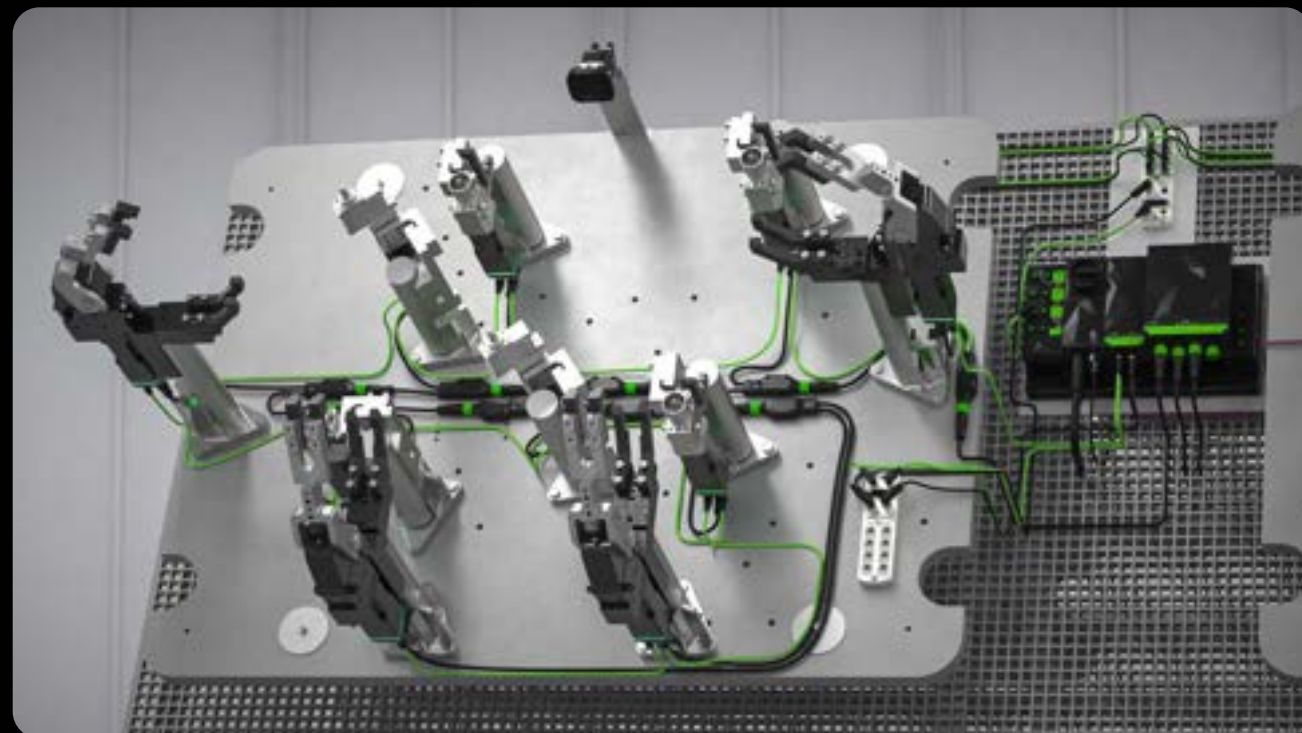
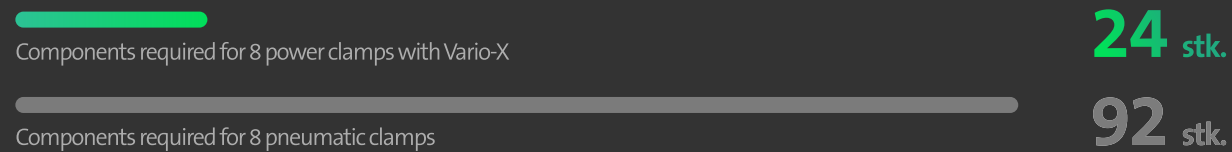

i In this automotive example, a robot inserts a door for machining. Electric grippers hold the part in place. After machining, the grippers open and the robot removes the workpiece. The Vario-X installation solution controls the system, requiring only a few cables and sensors, and monitors their status.

Automation without cabinets

Out of the cabinet and into the field. The Vario-X system focuses on decentralization. Hardware, software and installation concept work together seamlessly - from the automation system to the plug & play connectors.

Easy installation

Vario-X is like a building block system. Thanks to the modular design, you can easily connect individual components, which makes installation easier. Individual wiring and other time-consuming tasks are a thing of the past.

Faster commissioning

A modular design and clear connection points make it easy to transport and commission the systems at the customer's site. The low susceptibility of the modular design means that less qualified personnel can commission the system. If faults do occur, diagnostic functions help to resolve them quickly.

Easy scaling and expansion

Quick teach-in allows systems to be efficiently expanded with additional drives and actuators. Daisy-chain technology allows additional drives to be connected quickly and easily via h-distributors. If required, an additional Vario-X station can also be integrated, significantly increasing the flexibility and scalability of the system.

Digital Twin and Virtual Commissioning

The digital twin simplifies implementation by identifying potential problems early. It reduces commissioning time because systems can be optimized before physical implementation. It also helps with staffing shortages by allowing less experienced staff to work more efficiently. Condition monitoring gives you a real-time view of the status of your machines and systems. By identifying trends early, you can anticipate potential failures and prevent them with planned maintenance. This increases machine availability and optimizes maintenance costs.



Less energy consumption

Increase energy efficiency, reduce CO₂ emissions and minimize losses with the Vario-X system - an innovative solution for lower energy consumption and better controllability in industrial applications.

Up to 85% less power consumption

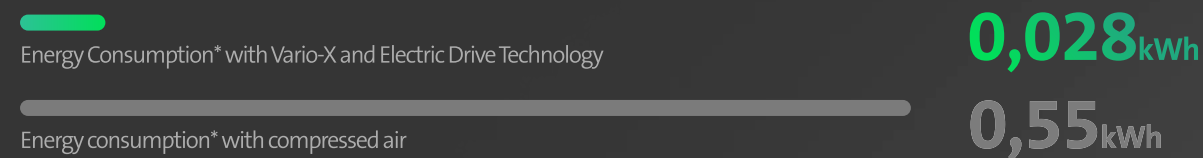

Reduced losses

Electric drives are almost loss-free. Pneumatic systems often lose compressed air due to leaks that are difficult to detect. These losses are eliminated with Vario-X.

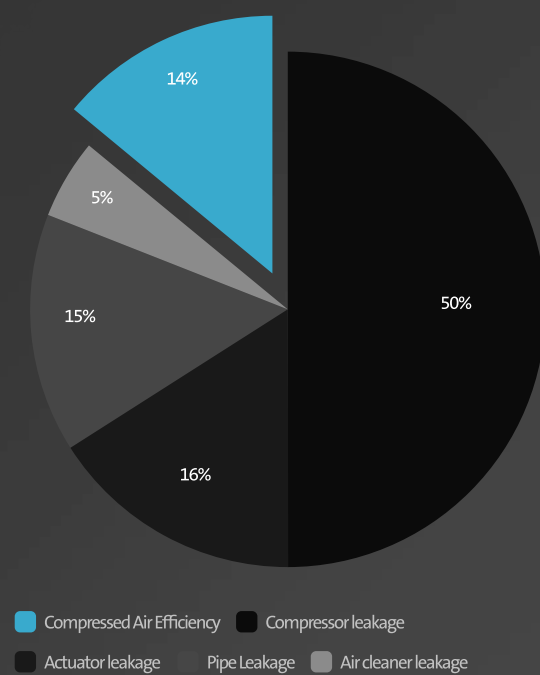

Low base consumption

Compared to pneumatic solutions, electric grippers have lower standby consumption.

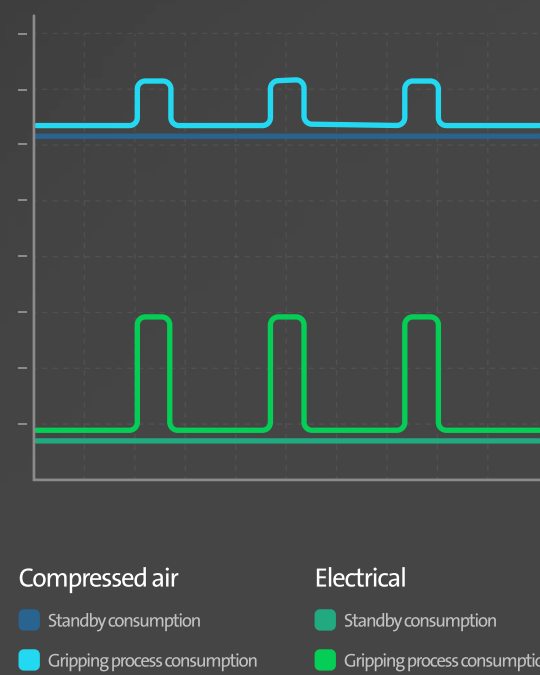

More sustainability

-59%

Climate change

-16%

Particulate matter formation

-82%

Shortage of raw materials (fossil)

Up to 60% less CO₂ equivalents [E-4 kg CO₂ eq]

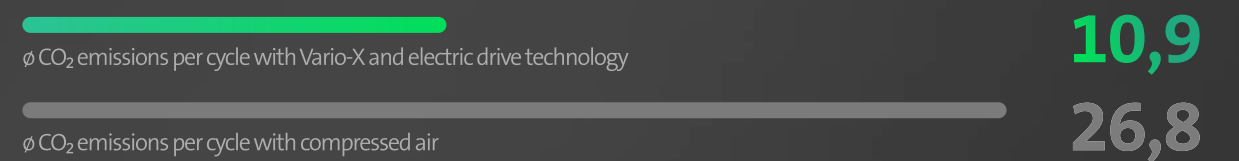

TÜVNORD

Life Cycle Assessment Study "Fixtures in Car Body Engineering"
DIN EN ISO 14040:2021 / DIN EN ISO 14044:2021

Healthy working environment



Less noise pollution

Vario-X significantly reduces noise levels. Pneumatic systems often generate a lot of noise when compressed air expands rapidly and passes through valves and components. Not only is this noise annoying, but it can also damage hearing over time.



Less air pollution

Vario-X improves air quality for workers. Compressed air often releases oil particles that degrade the air and pose a health risk, especially to those who regularly work in such environments.

*Average energy consumption on one gripper frame per gripping cycle with Vario-X.

Increased productivity

Using the Vario-X system revolutionizes production and significantly increases productivity. The ability to produce multiple models on a single system without changeover times maximizes efficiency. Lower failure rates through predictive maintenance increase system availability and minimize downtime.



Live data and built-in sensors

Servo-electric grippers require no external sensors. The system provides live data, constantly monitoring the position of the gripper and providing information about the quality of the workpiece.

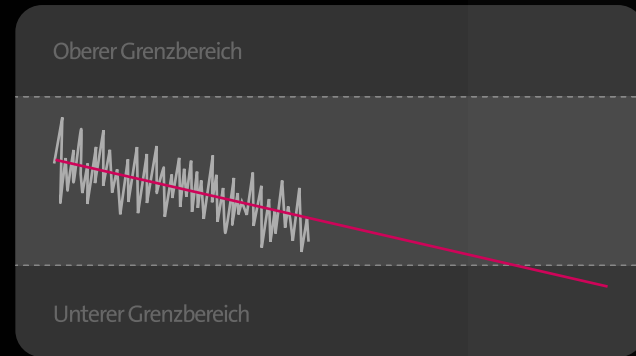

Predictive Maintenance

Vario-X continuously monitors the condition of the grippers. This allows maintenance to be planned in advance and unexpected failures to be avoided.

Position Offen	Position Geschlossen
<input type="text" value="130"/> deg	<input type="text" value="15"/> deg
Geschwindigkeit	Momentbegrenzung
<input type="text" value="3.500"/> rpm	<input type="text" value="1"/> Nm

Parameterization instead of programming

Instead of complex and time-consuming programming, Vario-X allows system components to be easily parameterized via a user-friendly interface. This means that settings and adjustments can be made quickly and intuitively without in-depth programming knowledge.

Time and cost savings

Teach-in time for servo-electric grippers

0,8 Min

Teach-in time with pneumatic grippers

7 Min

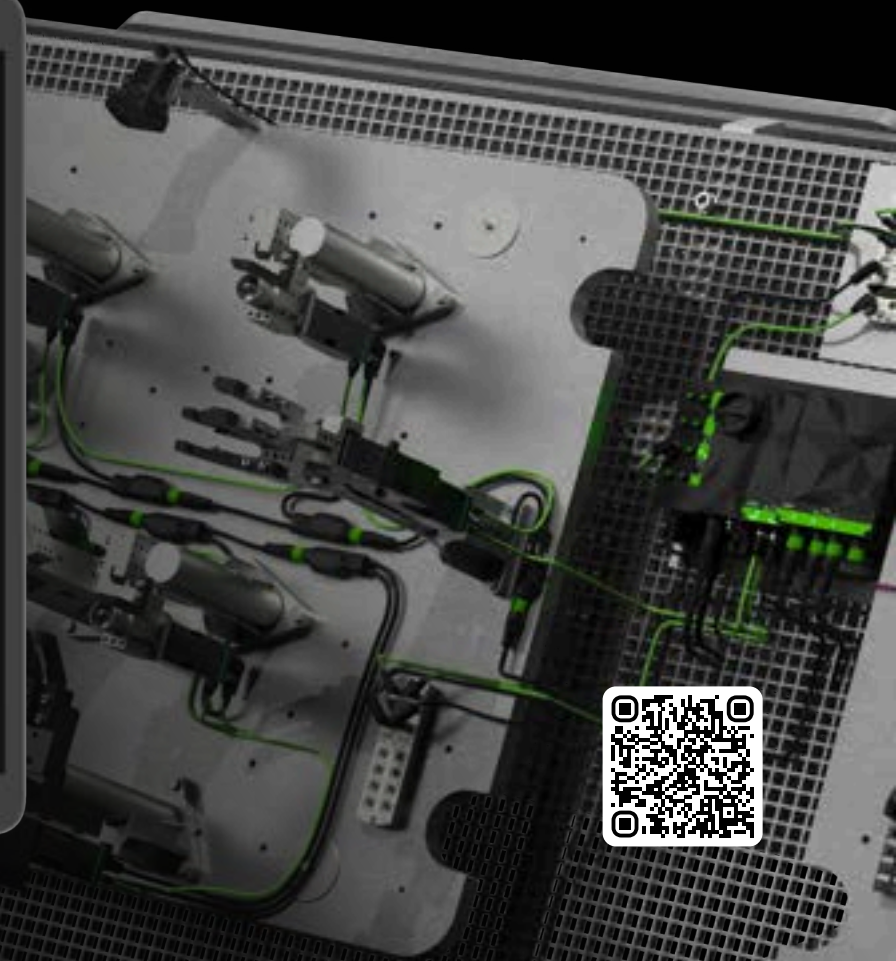
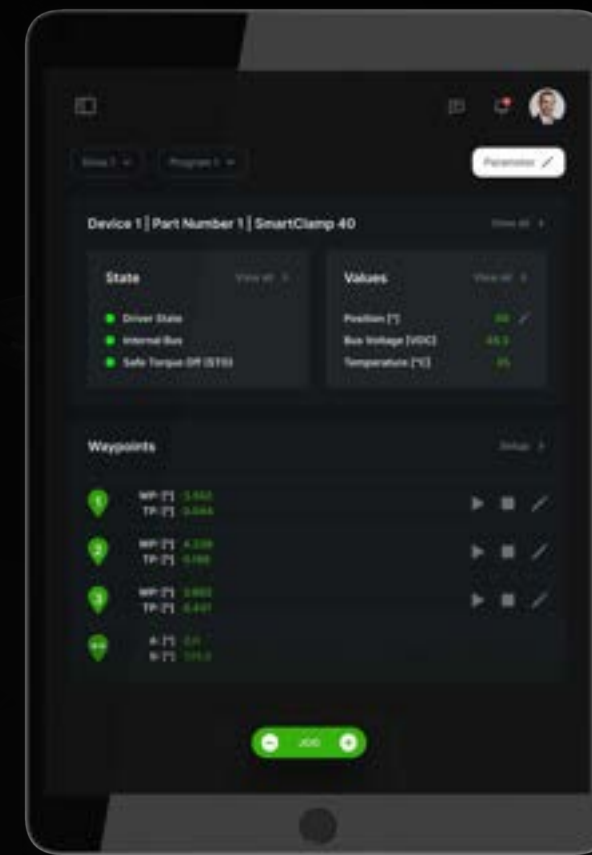

Teach-in instead of shimming

Electric grippers can be easily parameterized via software to define gripping positions and forces. Vario-X simplifies the teach-in process and allows grippers to be set quickly and accurately without manual intervention.

Multiple models

With built-in sensors, the system automatically recognizes different workpieces. As a result, it effortlessly produces multiple models with no changeover time, significantly increasing productivity.

More options, more freedom, more flexibility.

Vario-X offers everything you need for decentralized installation without a control cabinet. The modular design allows you to easily add or replace components, just like a building block system.

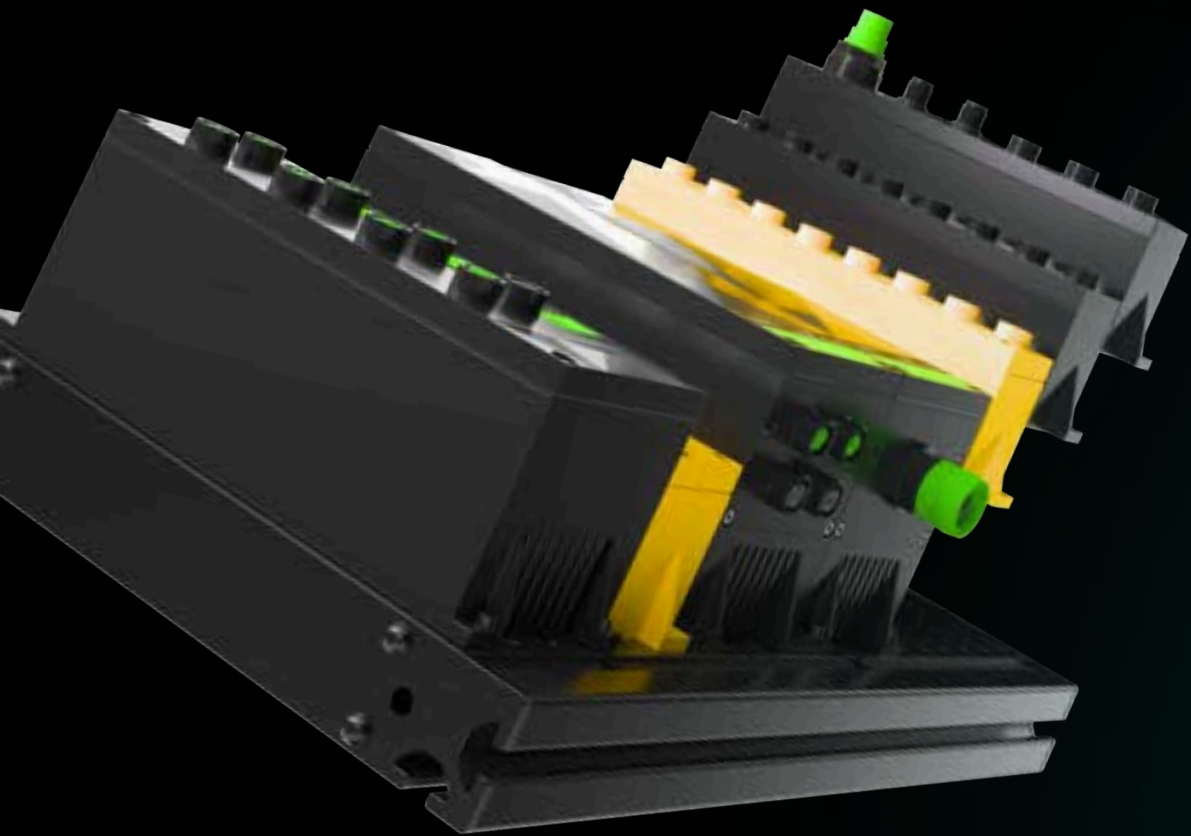

Our Portfolio

Murrelektronik simplifies industrial automation with smart solutions that are seamless and cost-effective. As a pioneer in decentralized electrical automation technology, our solutions bring signals, data and power directly to the processes, eliminating the need for control cabinets. Our ever-expanding portfolio now includes a wide range of products -

from connectors, I/O systems, power supplies and networking solutions to the Vario-X system, the quick and easy to install, modular all-in-one solution for cabinet-free automation. In line with our plug-and-play philosophy, we also offer comprehensive digital services for the installation, commissioning and maintenance of machines and systems.



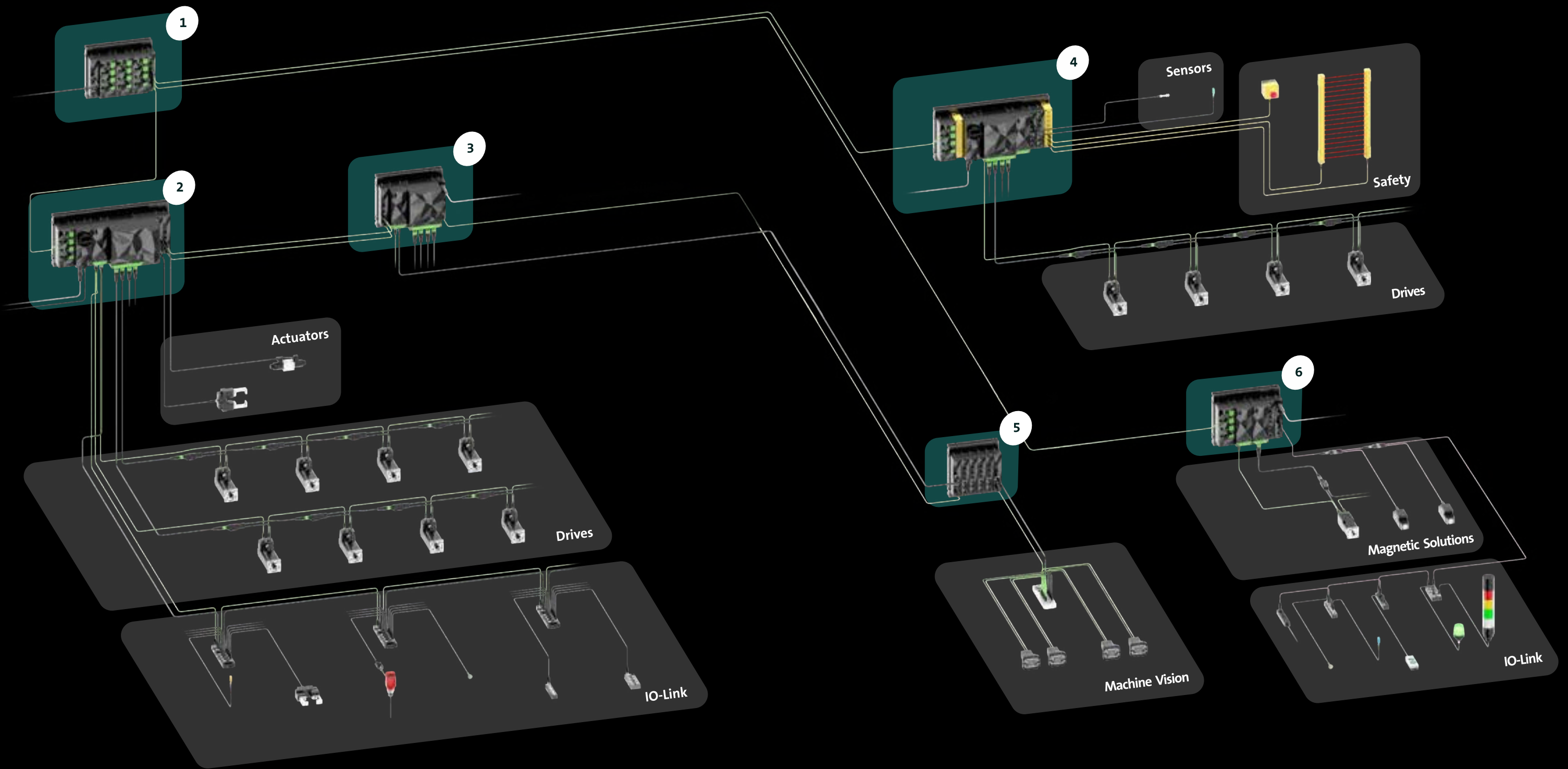

Vario-X as a superior control system

The IPC can be used as a central, higher-level controller and/or as an EDGE gateway. As an EDGE gateway, it processes data locally, filters it, and then transmits it to the cloud. This speeds up response times and increases reliability.

Modular and flexible solution

Vario-X modules can be flexibly combined. This allows you to divide your machine into sections, each with the appropriate Vario-X station to perform exactly the functions you need. This saves complex and time-consuming wiring to the control cabinet.

Vario-X stations:

- 1 Higher-level control system
 - 2 IPC, Power Supplies , I/O, STO
 - 3 Power Supplies
- 4 IPC, Safety PLC & I/O, Power Supplies, I/O, STO
 - 5 I/O
 - 6 IPC, Power Supplies, I/O

See our complete portfolio at a glance

Vario-X offers exceptional flexibility in system design, allowing the production line to be tailored to your needs and requirements. Systems can be customized and flexibly adapted, which greatly simplifies and speeds up production processes.

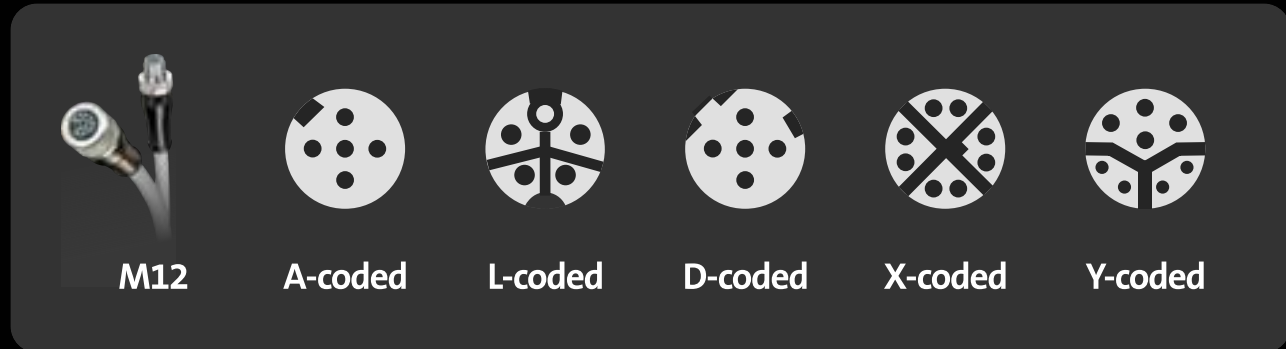

Backplane

The backplane supports the modules of the Vario-X station. The modules can be mounted side by side. It distributes the supply voltage, safety extra-low voltage, fieldbus and Gigabit Ethernet to the mounted devices.

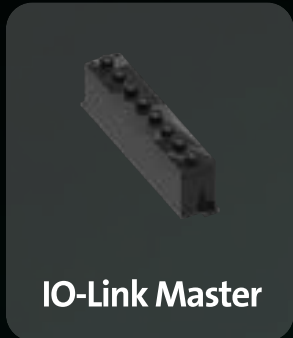
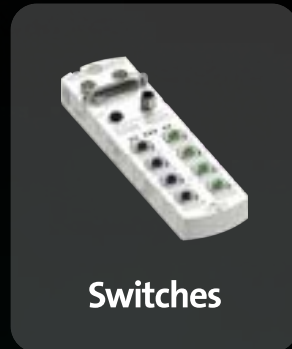

Decentral. Seamless. Sustainable.

We offer customized solutions for your application. Choose from our wide range of products - from connectors, I/O systems and power supplies to network solutions and the Vario-X system.



Decentralized. Flexible. Scalable.

Vario-X revolutionizes automation with a modular system. It relies on digital design, simplifies installation, accelerates commissioning, and promotes cost-efficiency and sustainability.

“With innovative technologies and customized solutions, Vario-X sets new standards and raises production processes in various industries to a new level. Murrelektronik's Vario-X team is here to support you.”



Olaf Prein

Head of Global Business Unit
Automation



Request now

Learn how Vario-X can revolutionize your production.



Automotive



Intralogistics



Packaging



Machine Tools

VARIOX

MURR
ELEKTRONIK

stay connected